

FEATURES

- 5V Version Available*
- Output Current of 100mA
- Very Low Quiescent Current
- Reverse Battery Protection
- Input-output Differential less than 0.6V
- Short Circuit protection
- Internal Thermal Overload Protection

APPLICATIONS

- Battery Powered Systems
- Portable Consumer Equipment
- Cordless Telephones
- Portable (Notebook) Computers
- Portable Instrumentation
- Radio Control Systems
- Personal Communication Equipment
- Toys
- Low Voltage Systems

GENERAL DESCRIPTION

The AMS116 series consists of positive fixed voltage regulators ideally suited for use in battery-powered systems. These devices feature very low quiescent current of 1mA or less when supplying 10mA loads. This unique characteristic and the extremely low input -output differential required for proper regulation (0.2V for output currents of 10mA) make the AMS116 ideal to use for standby power systems.

Like other regulators the AMS116 series also includes internal current limiting, thermal shutdown, and is able to withstand temporary power-up with mirror-image insertion.

The AMS116 is offered in the 3-pin TO-92 package and SOT-89 package.

ORDERING INFORMATION

PACKAGE TYPE		OPER. TEMP RANGE
TO-92	SOT-89	
AMS116N-X	AMS116L-X	IND

X =5V

*For additional available fixed voltages contact factory

PIN CONNECTIONS

**TO-92
Plastic Package (N)**

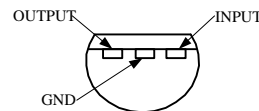

Bottom View

**SOT-89 Package
(L)**

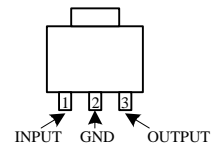

Top View

ABSOLUTE MAXIMUM RATINGS (Note 1)

Input Voltage	18V	Maximum Junction Temperature	+125°C
Operating Voltage Range	2.5V to 16V	Storage Temperature	-65°C to +150°C
Load Current	150mA	Lead Temperature (Soldering 25 sec)	265°C
Internal Power Dissipation	Internally Limited	ESD	2000V

ELECTRICAL CHARACTERISTICS

Electrical Characteristics at $T_J=25^\circ\text{C}$, $C_2 = 100\mu\text{F}$ unless otherwise specified.

PARAMETER	CONDITIONS (Note 2)	AMS116-X			Units
		Min.	Typ.	Max.	
Output Voltage	$V_{IN} = V_{OUT}+3\text{V}$	-3		+3	%
Line Regulation	$V_{IN} = V_{OUT}+3\text{V to }14\text{V}$		2	30	mV
Load Regulation	$5\text{mA} \leq I_o \leq 100 \text{mA}$		15	60	mV
Dropout Voltage	$I_o \leq 30 \text{mA}$		80	150	mV
	$I_o = 100 \text{mA}$		170	330	mV
Quiescent Current	$I_o \leq 10 \text{mA}$, $V_{IN} = V_{OUT}+3\text{V to }14\text{V}$		400	1000	μA
Ripple Rejection	$f_o = 120\text{Hz}$		80		dB
Temperature Coefficient	$I_o \leq 10 \text{mA}$, $V_{IN} = V_{OUT}+3\text{V to }14\text{V}$		± 35		$\text{mV}/^\circ\text{C}$

Note 1: Absolute Maximum Ratings are limits beyond which damage to the device may occur. For guaranteed performance limits and associated test conditions, see the Electrical Characteristics tables.

Note 2: See Circuit in Typical Applications. To ensure constant junction temperature, low duty cycle pulse testing is used.

Note 3: Limits appearing in **boldface** type apply over the entire junction temperature range for operation. Limits appearing in normal type apply for $T_A = T_J = 25^\circ\text{C}$.

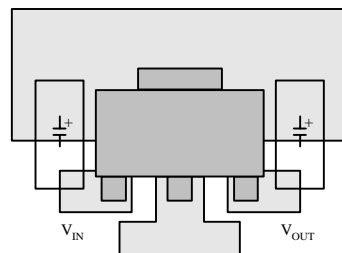

Figure 1. SOT-89 Board Layout

APPLICATION HINTS

Package Power Dissipation

The package power dissipation is the level at which the thermal sensor monitoring the junction temperature is activated. The AMS116 shuts down when the junction temperature exceeds the limit of 150°C. The junction temperature rises as the difference between the input power and output power increases. The mounting pad configuration on the PCB, the board material, as well as the ambient temperature affect the rate of temperature rise. The junction temperature will be low, even if the power dissipation is high, when the mounting of the device has good thermal conductivity. When mounted on the recommended mounting pad (figure1) the power dissipation for the SOT-89 package is 600mW. For operation above 25°C derate the power dissipation at 4.8mW/°C. To determine the power dissipation for shutdown when mounted, attach the device on the PCB and increase the input-to-output voltage until the thermal protection circuit is activated. Calculate the power dissipation of the device by subtracting the output voltage from the input voltage and multiply by the output current. The measurements should allow for the ambient temperature of the PCB. The value obtained from $P_D / (150^\circ\text{C} - T_A)$ is the derating factor. The PCB mounting pad should provide maximum thermal conductivity in order to maintain low device temperatures. As a general rule, the lower the temperature, the better the reliability of the device.

The thermal resistance when the device is mounted is equal to:

$$T_J = \theta_{JA} \times P_D + T_A$$

The internal limit for junction temperature is 150°C. If the ambient temperature is 25°C, then:

$$150^\circ\text{C} = \theta_{JA} \times P_D + 25^\circ\text{C}$$

$$\theta_{JA} = 125^\circ\text{C} / P_D$$

A simple way to determine P_D is to calculate $V_{IN} \times I_{IN}$ when the output is shorted. As the temperature rises, the input gradually will decrease. The P_D value obtained when the thermal equilibrium is reached, is the value that should be used.

The range of usable currents can be found from the graph in figure 2.

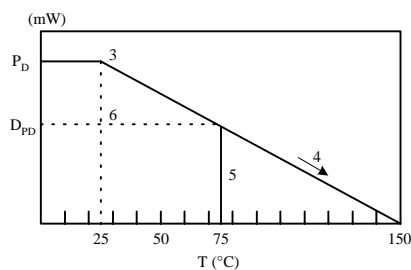

Figure 2

Procedure:

1. Find P_D .
2. P_{D1} is calculated as $P_D \times (0.8 - 0.9)$.
3. Plot P_{D1} against 25°C.
4. Connect P_{D1} to the point corresponding to the 150°C.

5. Take a vertical line from the maximum operating temperature (75°C) to the derating curve.
6. Read the value of P_D at the point where the vertical line intersects the derating curve. This is the maximum power dissipation, D_{PD} .

The maximum operating current is:

$$I_{OUT} = (D_{PD} / (V_{IN(MAX)} - V_O))$$

External Capacitors

The AMS116 series require an output capacitor for device stability. The value required depends on the application circuit and other factors.

Because high frequency characteristics of electrolytic capacitors depend greatly on the type and even the manufacturer, the value of capacitance that works well with AMS116 for one brand or type may not necessary be sufficient with an electrolytic of different origin. Sometimes actual bench testing will be the only means to determine the proper capacitor type and value. To obtain stability in all general applications a high quality 100µF aluminum electrolytic or a 47µF tantalum electrolytic can be used. A critical characteristic of the electrolytic capacitors is their performance over temperature. The AMS116 is designed to operate to -40°C, but some electrolytics will freeze around -30°C therefore becoming ineffective. In such case the result is oscillation at the regulator output. For all application circuits where cold operation is necessary, the output capacitor must be rated to operate at the minimum temperature. In applications where the regulator junction temperature will never be lower than 25°C the output capacitor value can be reduced by a factor of two over the value required for the entire temperature range (47µF for a high quality aluminum or 22µF for a tantalum electrolytic capacitor).

With higher output currents, the stability of AMS116 decreases. Considering the fact that in many applications the AMS116 is operated at only a few milliamps (or less) of output current, the output capacitor value can be reduced even further. For example, a circuit that is required to deliver a maximum of 10mA of output current from the regulator output will need an output capacitor of only half the value compared to the same regulator required to deliver the full output current of 100mA.

As a general rule, with higher output voltages the value of the output capacitance decreases, since the internal loop gain is reduced.

In order to determine the minimum value of the output capacitor, for an application circuit, the entire circuit including the capacitor should be bench tested at minimum operating temperatures and maximum operating currents. To maintain internal power dissipation and die heating to a minimum, the input voltage should be maintain at 0.6V above the output. Worst-case occurs just after input power is applied and before the die had the chance to heat up. After the minimum capacitance value has been found for the specific brand and type of electrolytic capacitor, the value should be doubled for actual use to cover for production variations both in the regulator and the capacitor.

TYPICAL PERFORMANCE CHARACTERISTICS

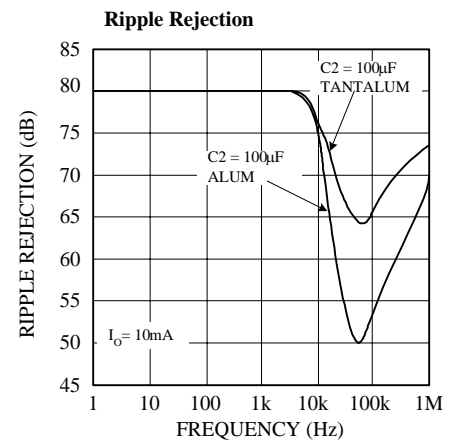
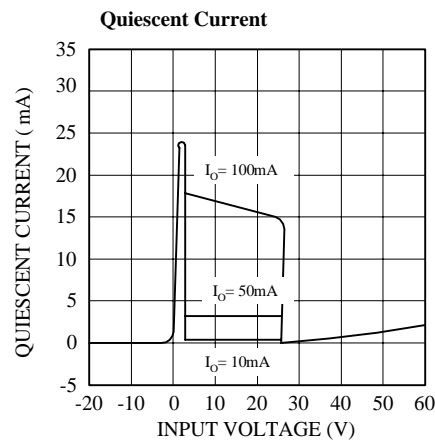
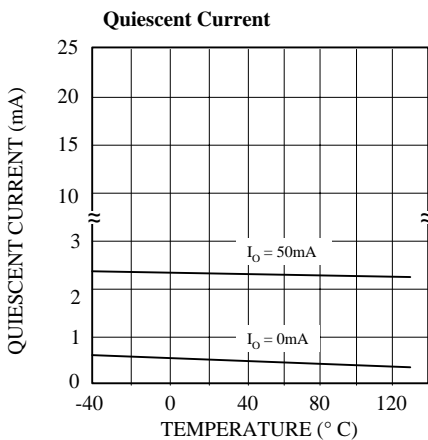
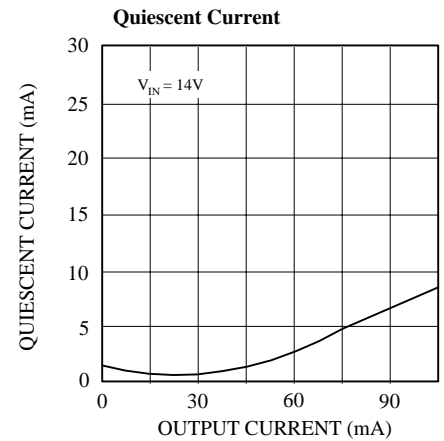
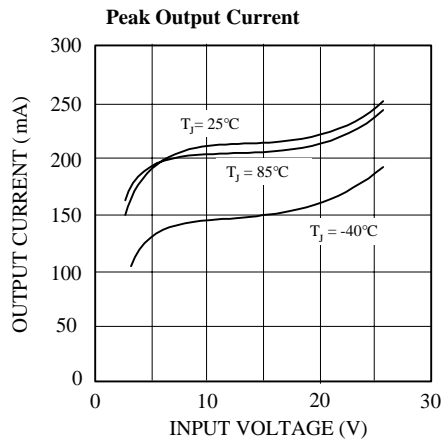
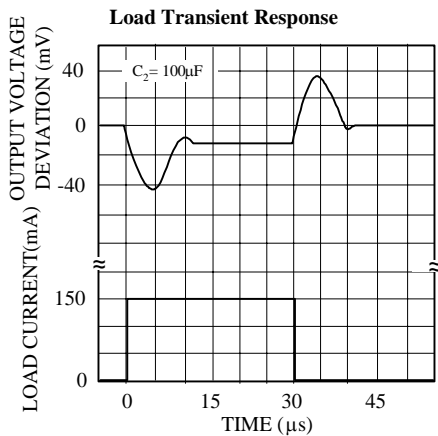
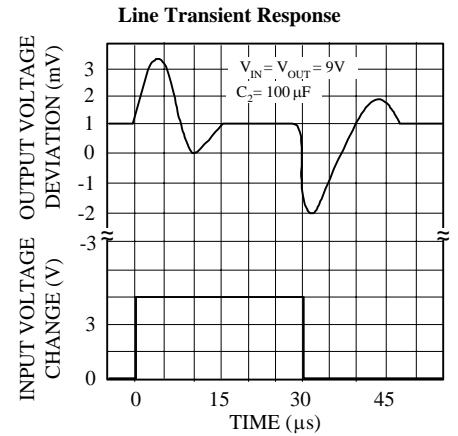
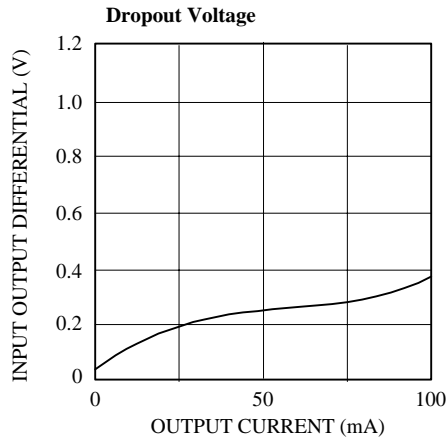
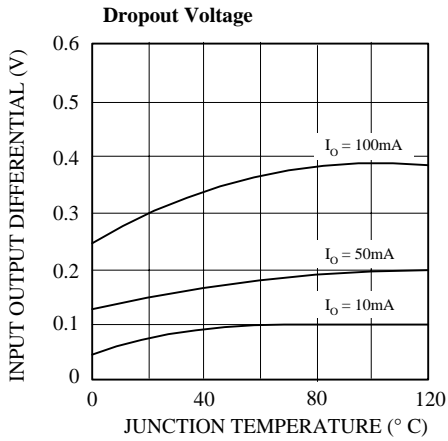

TYPICAL PERFORMANCE CHARACTERISTICS (Continued)

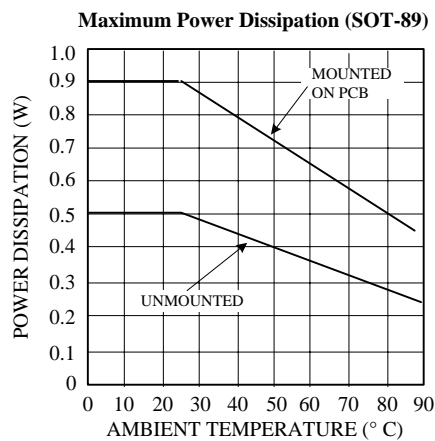
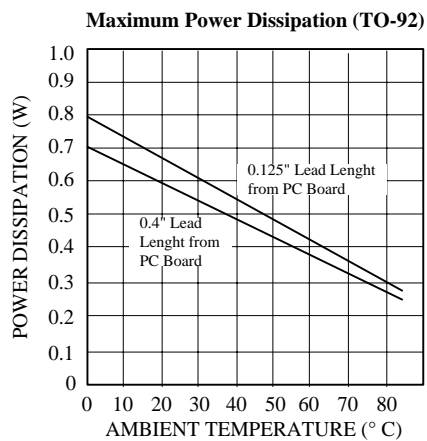
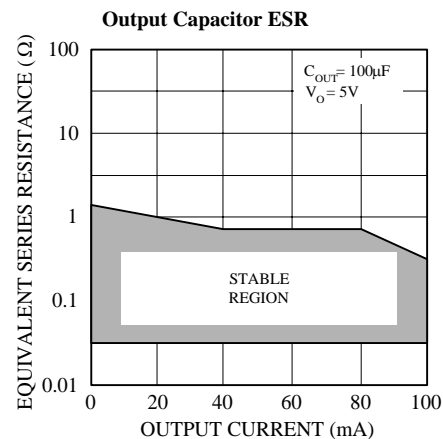
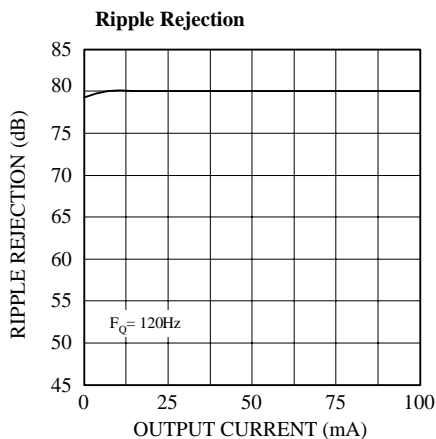
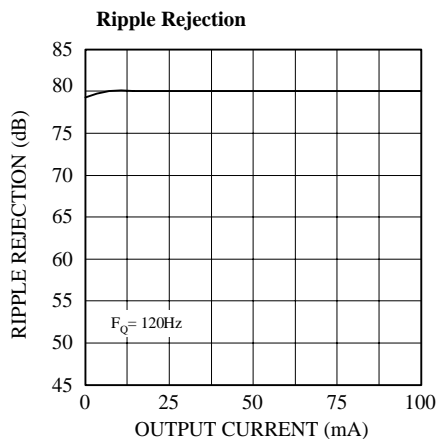

TYPICAL APPLICATIONS

Voltage Regulator Circuit

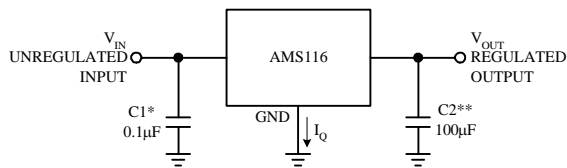

*Required if regulator is located far from power supply filter.

**C2 must be at least 100µF to maintain stability; it can be increased without bound to maintain regulation during transients and it should be located as close as possible to the regulator. This capacitor must be rated over the same operating temperature range like the regulator. The ESR of this capacitor is critical (see curve).

Voltage Boost Circuit

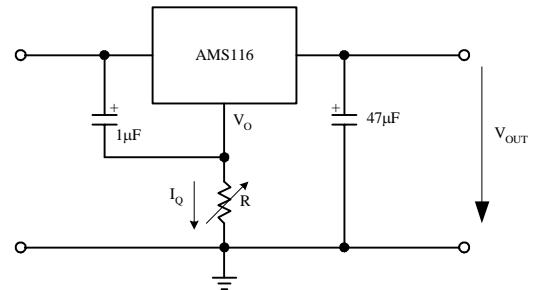

$$V_{OUT} = V_O + I_Q R$$

Current Boost Circuit

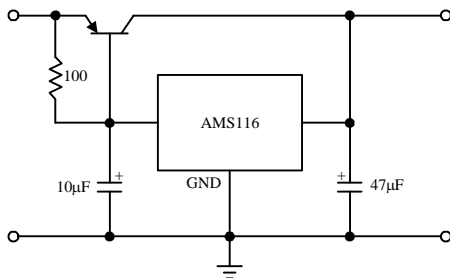

Current Regulator Circuit

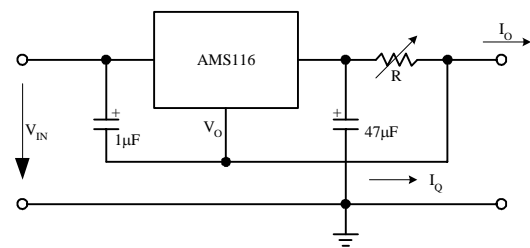

$$I_O = (V_O/R) + I_Q$$

PACKAGE DIMENSIONS inches (millimeters) unless otherwise noted.

3 LEAD TO-92 PLASTIC PACKAGE (N)

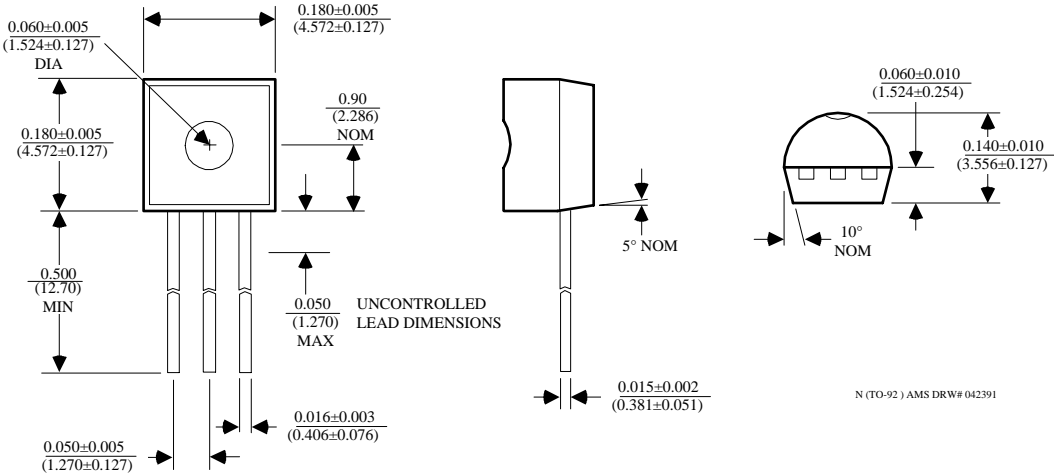

SOT-89 PLASTIC PACKAGE (L)

